

Motor Protection Circuit Breaker J7MN

MPCB system

- Rotary and switch types
- Rated operational current 32 A, 63 A and 100 A
- Switching capacity up to 100 kA/400 V
- Fixed short-circuit release = $13 \times I_u$
- Overload release adjustable $0.65 - 1 \times I_u$
- Motor protection CLASS 10
- Fulfill all needed standards

Options

- ON/OFF indication
- Trip alarm/indication
- Undervoltage release
- Shunt release
- Three phase busbar system
- Moulded plastic enclosures
- Door coupling rotary mechanisms
- Insulated Link modules



Ordering Information

Model Number Legend

1. Motor Protection Circuit Breaker

- | | | |
|-------------|----|----------------------------------|
| J7MN-□□-□□□ | 1) | Motor Protection Circuit Breaker |
| 1 2 3 | 2) | Type/range |
| | 3) | Setting range |

2. Options for MPCB





- | | | |
|--------------|----|-------------------------|
| J77MN-□□-□□□ | 1) | Options MPCB |
| 1 2 3 | 2) | Auxiliary contacts |
| | | T: Trip indicator |
| | | U: Undervoltage release |
| | | S: Shuntrelease |
| | | DC: Door-coupling |
| | | HU: DIN-rail adaptors |
| | | V: Link modules |
| | | PF: Enclosure |
| | 3) | Other specifications |

3. Busbars, line side terminals and shrouds





- | | | |
|-------------|----|----------------------|
| J75-□□□-□□□ | 1) | Options MPCB |
| 1 2 3 | 2) | CPM: Busbars |
| | | BTC: Line side |
| | | TA: Shrouds |
| | 3) | Other specifications |



■ System overview

Motor Protection Circuit Breaker



	Rated Current In	Suitable for motors 3~400 V	Setting range Thermal Overload Release	Instantaneous Short Circuit Release	Short Circuit Breaking Capacity at 3~400 V	Type
	A	kW	A	A	kA (Icu)	
	0.16	-	0.10 - 0.16	2.1	100	J7MN-3P-E16
	0.25	0.06	0.16 - 0.25	3.3	100	J7MN-3P-E25
	0.4	0.09	0.25 - 0.4	5.2	100	J7MN-3P-E4
	0.63	0.18	0.4 - 0.63	8.2	100	J7MN-3P-E63
	1	0.25	0.63 - 1	13	100	J7MN-3P-1
	1.6	0.55	1 - 1.6	20.8	100	J7MN-3P-1E6
	2.5	0.75	1.6 - 2.5	32.5	100	J7MN-3P-2E5
	4	1.5	2.5 - 4	52	100	J7MN-3P-4
	6	2.2	4 - 6	78	100	J7MN-3P-6
	8	3	5 - 8	104	100	J7MN-3P-8
	10	4	6 - 10	130	50	J7MN-3P-10
	13	5.5	9 - 13	169	50	J7MN-3P-13
	17	7.5	11 - 17	221	20	J7MN-3P-17
	22	7.5	14 - 22	286	15	J7MN-3P-22
	26	11	18 - 26	338	15	J7MN-3P-26
32	15	22 - 32	416	15	J7MN-3P-32	
	0.16	-	0.10 - 0.16	2.1	100	J7MN-3R-E16
	0.25	0.06	0.16 - 0.25	3.3	100	J7MN-3R-E25
	0.4	0.09	0.25 - 0.4	5.2	100	J7MN-3R-E4
	0.63	0.18	0.4 - 0.63	8.2	100	J7MN-3R-E63
	1	0.25	0.63 - 1	13	100	J7MN-3R-1
	1.6	0.55	1 - 1.6	20.8	100	J7MN-3R-1E6
	2.5	0.75	1.6 - 2.5	32.5	100	J7MN-3R-2E5
	4	1.5	2.5 - 4	52	100	J7MN-3R-4
	6	2.2	4 - 6	78	100	J7MN-3R-6
	8	3	5 - 8	104	100	J7MN-3R-8
	10	4	6 - 10	130	100	J7MN-3R-10
	13	5.5	9 - 13	169	100	J7MN-3R-13
	17	7.5	11 - 17	221	50	J7MN-3R-17
	22	7.5	14 - 22	286	50	J7MN-3R-22
	26	11	18 - 26	338	50	J7MN-3R-26
32	15	22 - 32	416	50	J7MN-3R-32	
	26	12.5	18 - 26	338	50	J7MN-6R-26
	32	15	22 - 32	416	50	J7MN-6R-32
	40	18.5	28 - 40	520	50	J7MN-6R-40
	50	22	34 - 50	650	50	J7MN-6R-50
	63	30	45 - 63	819	50	J7MN-6R-63
	63	30	45 - 63	819	50	J7MN-9R-63
	75	37	55 - 75	975	50	J7MN-9R-75
	90	45	70 - 90	1170	50	J7MN-9R-90
	100	-	80 - 100	1300	50	J7MN-9R-100





Accessories

	Description	Mounting place	Max. per MPCB	Contacts		Rated Operating Current			Type
				NO	NC	AC15 24 V A	240 V A	AC1 240 V A	
Transverse Auxiliary 	Contact block	Front	1	1	1	3	2	5	J77MN-11F
				2	-	3	2	5	J77MN-20F
				-	2	3	2	5	J77MN-02F
Side Auxiliary 	Contact block	Left hand side	1	1	1	6	4	10	J77MN-11S
				2	-	6	4	10	J77MN-20S
				-	2	6	4	10	J77MN-02S
Any Trip Alarm 	Signalling switch suitable for J7MN-3	Left hand side	1	1	1	6	4	10	J77MN-TA-11S
	Signalling switch suitable for J7MN-6 & J7MN-9	Left hand side	1	1	1	6	4	10	J77MN-TB-11S
Short circuit Trip Alarm 	Signalling switch	Left hand side	1	1	1	6	4	10	J77MN-T-11S

	Description	Mounting place	Max. per MPCB	Rated voltages		Type	
				24 V	240 V		
Undervoltage Release 	Trips the circuit-breaker when the voltage is interrupted. Prevents the motor from being re-started accidentally when the voltage is restored, suitable for EMERGENCY STOP acc. to VDE 0113	Right hand side	1	24 V 50 Hz, 28 V 60 Hz		J77MN-U-24	
					110 - 127 V 50 Hz, 120 V 60 Hz		J77MN-U-110
					220 - 230 V 50 Hz, 240 - 260 V 60 Hz		J77MN-U-230
					240 V 50 Hz, 277 V 60 Hz		J77MN-U-240
					380 - 400 V 50 Hz, 440 - 460 V 60 Hz		J77MN-U-400
					415 - 440 V 50 Hz, 460 - 480 V 60 Hz		J77MN-U-415
Shunt Release 	Trips the circuit-breaker when the release coil energized.	Right hand side	1	24 V 50 Hz, 28 V 60 Hz		J77MN-S-24	
					110 - 127 V 50 Hz, 120 V 60 Hz		J77MN-S-110
					220 - 230 V 50 Hz, 240 - 260 V 60 Hz		J77MN-S-230
					240 V 50 Hz, 277 V 60 Hz		J77MN-S-240
					380 - 400 V 50 Hz, 440 - 460 V 60 Hz		J77MN-S-400
					415 - 440 V 50 Hz, 460 - 480 V 60 Hz		J77MN-S-415

	Description	Type
Enclosure 	Plastic enclose with rotary operating mechanism, lockable space for aux. contact + release, IP65	J77MN-PF-3R
	Enclose with rotary operating mechanism yellow - red, lock space for aux. contact + release, IP65	J77MN-PFC-3R

	Description	Applicable MPCBs	Shaft length	Type
Door-coupling rotary mechanism IP65; black/grey 	The door locking device prevents accidental opening of the cubicle door in the ON position of the circuit-breaker. The OFF position can be locked with up to 3 padlocks	J7MN-3R	115 mm	J77MN-DC-3R-115-B
			315 mm	J77MN-DC-3R-315-B
		J7MN-6R	115 mm	J77MN-DC-6R-115-B
			315 mm	J77MN-DC-6R-315-B
		J7MN-9R	115 mm	J77MN-DC-9R-115-B
			315 mm	J77MN-DC-9R-315-B
Door-coupling rotary mechanism IP65; red/yellow 		J7MN-3R	115 mm	J77MN-DC-3R-115-RY
			315 mm	J77MN-DC-3R-315-RY
		J7MN-6R	115 mm	J77MN-DC-6R-115-RY
			315 mm	J77MN-DC-6R-315-RY
		J7MN-9R	115 mm	J77MN-DC-9R-115-RY
			315 mm	J77MN-DC-9R-315-RY





	Description	Type	
Link modules 	Mechanical and electrical connection between Motor Protection Circuit Breaker and Contactor. Up-to max. 32 A.	Mini Motor Contactor J7KNA	J77MN-VKA-3
		Motor Contactor J7KN	J77MN-VKN-3
		Motor Contactor J7KNG	J77MN-VKG-3
	Electrical connection between Motor Protection Circuit Breaker and Contactor.	Up-to 32 A	J77MN-VD-3
		Up-to 63 A	J77MN-VD-6
	Up-to 100 A	J77MN-VD-9	
DIN-rail adaptors 	For mechanical fixing of circuit-breaker and contactor. With two moveable DIN-rail clips for easy mounting & replacing. Can be connected to one 35W x 15H mm DIN-rail or two 35W x 7.5H mm DIN-rails.	For J7MN-3 and J7KN(G)-10 up-to J7KN(G)-40	J77MN-HU-3
		For J7MN-6 and J7KN(G)-24 up-to J7KNG-40 and/or J7KN-62	J77MN-HU-6
	For J7MN-9 and J7KN-50 up-to J7KN-74	J77MN-HU-9	
Scale cover sealable 	for covering the current setting scale (1 bag with 10 units)	J77MN-K	
Push-in lugs 	for screwing the circuit-breaker onto mounting plates. 2 units required (1 bag with 20 units)	J77MN-L	
Insulation barriers 	Up to 600 V acc. UL 489 for increased distances and clearances acc. to UL Type "E" 4 pcs per device (2 pcs on each side) (pack 2 units)	J77MN-TB100	

Insulated 3-Phase Busbar System IP20

	Description	Connection type	Version	For Units (MPCB)	Pack pcs	Type
	3-phase busbars; modular spacing = 45 mm	Spade	for 2 units	J7MN-3P;	1	J77MN-CPM-3-45-2S
			for 3 units	J7MN-3R	1	J77MN-CPM-3-45-3S
			for 4 units		1	J77MN-CPM-3-45-4S
			for 5 units		1	J77MN-CPM-3-45-5S
	Line side terminal 3-pole, connection from above; conductor cross-section solid or stranded 6-25 mm ² with end sleeve 4-16 mm ²	Spade	acc. IEC/EN 60947-1, 60947-2, 60947-4-1 and VDE 0660	J7MN-3P; J7MN-3R	1	J77MN-BTC-63-SE
	Line side terminal 3-pole, connection from above; conductor cross-section solid or stranded 6-25 mm ² with end sleeve 4-16 mm ²	Spade	up to 600V acc. UL 489	J7MN-3P; J7MN-3R	1	J77MN-BTC-63-SEV
	Shrouds for unused terminals on busbar system	Spade		J7MN-3P; J7MN-3R	1	J77MN-TA-63S
	3-phase busbars; modular spacing = 45 mm	Pin	for 2 units	J7MN-3P;	1	J77MN-CPM-3-45-2
			for 3 units	J7MN-3R	1	J77MN-CPM-3-45-3
			for 4 units		1	J77MN-CPM-3-45-4
			for 5 units		1	J77MN-CPM-3-45-5
	3-phase busbars; modular spacing = 54 mm	Pin	for 2 units	J7MN-3P;	1	J77MN-CPM-3-54-2
			for 3 units	J7MN-3R	1	J77MN-CPM-3-54-3
			for 4 units		1	J77MN-CPM-3-54-4
			for 5 units		1	J77MN-CPM-3-54-5
	Line side terminal 3-pole, connection from above; conductor cross-section solid or stranded 6-25 mm ² with end sleeve 4-16 mm ²	Pin	acc. IEC/EN 60947-1, 60947-2, 60947-4-1 and VDE 0660	J7MN-3P; J7MN-3R	1	J77MN-BTC-63-E
	Line side terminal 3-pole, connection from above; conductor cross-section solid or stranded 6-25 mm ² with end sleeve 4-16 mm ²	Pin	up to 600V acc. UL 489	J7MN-3P; J7MN-3R	1	J77MN-BTC-63-EV
	Shrouds for unused terminals on busbar system	Pin		J7MN-3P; J7MN-3R	1	J77MN-TA-63
	3-phase busbars; modular spacing = 55 mm	Pin	for 2 units	J7MN-6P; J7MN-6R	1	J77MN-CPM-6-55-2

■ Components for Fuseless Load Feeders, DIN-rail Mounting

Type of coordination „1“ 3 × 415 V 10 kA (other conditions on request)

Motor	Contactor	Link-module	DIN-rail adaptor	Circuit-breaker
3-400 V up to ...KW	 Range	 Model	 Model	 Range
4	J7KNA-09	J77MN-VKA	Not needed	J7MN-3P / J7MN-3R
	J7KN-10D	J77MN-VKN-3		
	J7KNG-10-xx D	J77MN-VKG-3		
5.5	J7KNA-12	J77MN-VKA	Not needed	J7MN-3P / J7MN-3R
	J7KN-14D	J77MN-VKN-3		
	J7KNG-14-xx D	J77MN-VKG-3		
7.5	J7KN-18D	J77MN-VKN-3	Not Needed	J7MN-3P / J7MN-3R
	J7KNG-18-xx D	J77MN-VKG-3		
11	J7KN-22D	J77MN-VKN-3	Not Needed	J7MN-3P / J7MN-3R
	J7KNG-22-xx D	J77MN-VKG-3		
	J7KN(G)-24	J77MN-VD-3	J77MN-HU-3	J7MN-6R
	J7KN-24	J77MN-VD-6	J77MN-HU-6	
	J7KNG-24	J77MN-VDG-6		
15	J7KN(G)-32	J77MN-VD-3	J77MN-HU-3	J7MN-3P / J7MN-3R
	J7KN-32	J77MN-VD-6	J77MN-HU-6	J7MN-6R
	J7KNG-32	J77MN-VDG-6		
18.5	J7KN-40	J77MN-VD-6	J77MN-HU-6	J7MN-6R
	J7KNG-40	J77MN-VDG-6		
22	J7KN-50	J77MN-VD-6	J77MN-HU-6	J7MN-6R
30	J7KN-62	J77MN-VD-6	J77MN-HU-6	J7MN-6R
	J7KN-62	J77MN-VD-9	J77MN-HU-9	J7MN-9R
37	J7KN-74	J77MN-VD-9	J77MN-HU-9	J7MN-9R
45	J7KN-90	Not available	Not available	J7MN-9R
55	J7KN-115	Not available	Not available	J7MN-9R



Specifications

Engineering data and Characteristics

Technical Data according to IEC/EN 60947-1, 60947-2, 60947-4-1 and VDE 0660

This table shows the rated ultimate short-circuit breaking capacity I_{cu} and the rated service short-circuit breaking capacity I_{cs} of the J7MN circuit-breakers with different operational voltages as a function of the rated current I_n of the circuit-breakers. The circuit-breakers can be fed at the top or bottom supply terminals without any reduction of the rated data.

If the short-circuit current exceeds the rated short-circuit breaking capacity of the circuit-breaker specified in the tables at the installation point, a back-up fuse is to be used. The maximum rated current for the back-up fuse is specified in the tables. These fuses are only suitable for the short-circuit-currents as indicated on the fuses.

Circuit-breaker	Rated current I_n	up to AC 240V ¹			up to AC 400V ¹ up to AC 415V ²			up to AC 440V ¹ up to AC 460V ²			up to AC 500V ¹ up to AC 525V ²			up to AC 690V ¹		
		I_{cu}	I_{cs}	max. fuse ³ (gL/gG)	I_{cu}	I_{cs}	max. fuse ³ (gL/gG)	I_{cu}	I_{cs}	max. fuse ³ (gL/gG)	I_{cu}	I_{cs}	max. fuse ³ (gL/gG)	I_{cu}	I_{cs}	max. fuse ³ (gL/gG)
Type	A	kA	kA	A	kA	kA	A	kA	kA	A	kA	kA	A	kA	kA	A
J7MN-3P	0.16 to 0.63	100	100	--	100	100	--	100	100	--	100	100	--	100	100	--
	1	100	100	--	100	100	--	100	100	--	100	100	--	100	100	--
	1.6	100	100	--	100	100	--	100	100	--	100	100	--	3	3	20
	2.5	100	100	--	100	100	--	100	100	--	50	100	--	3	3	35
	4	100	100	--	100	100	--	100	38	50	15	38	50	3	3	40
	6	100	100	--	100	100	--	50	11	50	10	11	40	3	3	50
	8	100	100	--	100	100	--	15	11	63	10	8	40	3	3	63
	10	100	100	--	50	38	80	15	11	63	6	8	63	3	3	63
	13	100	100	--	50	38	80	10	8	80	6	5	63	3	3	63
	17	50	38	--	20	15	100	10	8	80	6	5	80	3	3	63
	22	40	30	125	15	11	100	8	6	100	6	5	80	3	3	63
	26	40	30	125	15	11	100	8	6	100	6	5	80	3	3	63
32	30	22	125	15	11	100	6	4	100	5	4	80	3	3	63	
J7MN-3R	0.16 to 1.0	100	100	--	100	100	--	100	100	--	100	100	--	100	100	--
	1.6	100	100	--	100	100	--	100	100	--	100	100	--	100	100	--
	2.5	100	100	--	100	100	--	100	100	--	100	100	--	8	8	35
	4	100	100	--	100	100	--	100	100	--	100	100	--	8	8	40
	6	100	100	--	100	100	--	100	100	--	100	100	--	6	6	50
	8	100	100	--	100	100	--	50	38	80	50	38	63	6	6	63
	10	100	100	--	100	100	--	50	38	80	50	38	80	6	6	63
	13	100	100	--	100	100	--	50	38	80	42	32	80	6	6	63
	17	100	100	--	50	38	100	20	15	80	10	8	80	4	4	63
	22	100	100	--	50	38	125	20	15	100	10	8	80	4	4	63
	26	100	100	--	50	38	125	20	15	100	10	8	80	4	4	63
	32	100	100	--	50	38	125	20	15	100	10	8	80	4	4	63
J7MN-6R	26	100	100	--	50	50	125	35	27	125	12	9	100	5	5	80
	32	100	100	--	50	50	125	35	27	125	10	8	100	5	5	80
	40	100	100	--	50	50	160	35	27	125	10	8	100	5	5	80
	50	100	100	--	50	50	160	35	27	125	10	8	100	5	5	80
	63	100	100	--	50	50	160	35	27	160	10	8	100	5	5	80
J7MN-9R	63	100	100	--	50	38	160	40	30	160	12	9	100	6	5	80
	75	100	100	--	50	38	160	40	30	160	8	6	125	5	4	100
	90	100	100	--	50	38	160	40	30	160	8	6	125	5	4	125
	100	100	100	--	50	38	160	40	30	160	8	6	125	5	4	125

-- No back-up fuse required

*1 10% overvoltage

*2 5% overvoltage

*3 Back up fuse required if short-circuit current at installation point > I_{cu}

Technical Data according to IEC/EN 60947-1, 60947-2, 60947-4-1 and VDE 0660

Main Circuit



Type		J7MN-3P	J7MN-3R	J7MN-6R	J7MN-9R
Number of poles		3			
Max. rated current Inmax (=max. rated operational current Ie)		32 A	32 A	63 A	100 A
Permissible ambient temperature	Storage/transport	-50 to +80°C			
	Operation	-20 to +60°C			
	Storage/transport	-58 to +176°F			
	Operation	-4 to +140°F			
Rated insulation voltage Ui		690 V ¹		1000 V ²	
Rated impulse withstand voltage Uimp		6 kV		8 kV	
Rated operational voltage Ue		690 V			
Rated frequency		50/60 Hz			
Utilization category	IEC 60 947-2 (circuit-breaker)	A			
	IEC 60 947-4-1 (motor starter)	AC3			
Class	acc. to IEC 60 947-4-1	10			
Power loss Pv per circuit-breaker	In -> up to 4 A	9.8 W		-	
dependent on rated current In	In -> 6 up to 26 A	8 W		-	
(upper setting range)	In -> 32 A	3.9 W		-	
R per conducting path = P/I ² × 3	In -> 26 up to 63 A	-	-	12.6 W	-
	In -> up to 63 A W	-	-	-	11.9 W
	In -> 75 up to 100 A	-	-	-	15 W
Shock resistance	acc. to IEC 68 Part 2-27	25 g			
Degree of protection	acc. to IEC 60 529	IP 20			
Shock hazard protection	acc. to DIN VDE 0106 Part 100	safe against finger touch			
Weight		0.32 kg	0.36 kg	1 kg	2.2 kg
Temperature compensation	acc. to IEC 60 947-4-1	-20 to +60°C			
Mechanical endurance	operating cycles	100,000		50,000	
Electrical endurance	operating cycles	100,000		25,000	
Max. operating frequency per hour (motor starts)	1/h	25			

¹ Suitable at 690 V for: earthed-neutral systems, overvoltage category I to IV, pollution degree 3 (standard-industry): U_{imp} = 6 kV.

² Suitable at 1000 V for: earthed-neutral systems, overvoltage category I to IV, pollution degree 3 (standard-industry): U_{imp} = 8 kV.

Data for other conditions on request.

Conductor cross-sections for main circuit

Type		J7MN-3	J7MN-6	J7MN-9
Screw type, terminal type		Pz2 	Pz2 	4 mm hexagon socket screw 
Tightening torque		0.8 to 2.5 Nm	3 to 4.5 Nm	4 to 6 Nm
		7 to 22 lb-in	26 to 39 lb-in	35 to 53 lb-in
Conductor cross-sections	solid	1 x (1 to 10) mm ²	1 x (0.75 to 35) mm ²	1 x (2.5 to 70) mm ²
		2 x (1 to 6) mm ²	2 x (0.75 to 25) mm ²	2 x (2.5 to 50) mm ²
		1 x (18 to 8) AWG	1 x (18 to 2) AWG	1 x (12 to 2/0) AWG
		2 x (18 to 10) AWG	2 x (18 to 4) AWG	2 x (12 to 1/0) AWG
	stranded	1 x (1 to 6) mm ²	1 x (0.75 to 35) mm ²	1 x (2.5 to 70) mm ²
		2 x (1 to 6) mm ²	2 x (0.75 to 25) mm ²	2 x (2.5 to 50) mm ²
		1 x (18 to 10) AWG	1 x (18 to 2) AWG	1 x (12 to 2/0) AWG
		2 x (18 to 10) AWG	2 x (18 to 4) AWG	2 x (12 to 1/0) AWG
	flexible	1 x (1 to 6) mm ²	1 x (0.75 to 25) mm ²	1 x (2.5 to 50) mm ²
		2 x (0.75 to 4) mm ²	2 x (0.75 to 16) mm ²	2 x (2.5 to 35) mm ²
		1 x (18 to 10) AWG	1 x (18 to 4) AWG	1 x (12 to 1/0) AWG
		2 x (18 to 10) AWG	2 x (18 to 6) AWG	2 x (10 to 2) AWG

Auxiliary switches

Aux. Type	Switching capacity		Control voltage	
J77MN-11F/20F/02F & J7MN-T(A/B) Front transverse auxiliary switch with 1 NO + 1 NC, 2 NO, 2 NC	Rated operational voltage	Ue	24 VAC	240 VAC
	Rated operational current	Ie/AC-15	3 A	2 A
		Ie/AC-12 Ith	5 A	5 A
	Rated operational voltage	Ue L/R 200 ms	24 VDC	220 VDC
J77MN-11S/20S/02S Lateral auxiliary switch with 1 NO + 1 NC, 2 NO, 2 NC & two signalling switches with 1 NO + 1 NC	Rated operational voltage	Ue	24 VAC	240 VAC
	Rated operational current	Ie/AC-15	6 A	4 A
		Ie/AC-12 Ith	10 A	
	Rated operational voltage	Ue L/R 200 ms	24 VDC	220 VDC
J77MN-U Undervoltage release	Power consumption	during pick-up	8.5 VA / 6 W	
		uninterrupted duty	3 VA / 1.2 W	
	Response voltage	trip	0.7 to 0.35 × Us (V)	
		pick-up	0.85 to 1.1 × Us (V)	
J77MN-S Shunt release	Power consumption	during pick-up	8.5 VA / 6 W	
		uninterrupted duty	3 VA / 1.2 W	
	Response voltage	trip	0.7 to 1.1 × Us (V)	
		Short-circuit protection for auxiliary and control circuits		Fuse gL/gG
		Miniature circuit breaker C-characteristic	6 A	
Conductor cross-sections for auxiliary and control circuits		Screw-type Pz2		
		solid	1 x (0.5 to 2.5) / 2x (0.5 to 2.5) mm ²	
		flexible	1 x (0.5 to 4) / 2 x (0.75 to 2.5) mm ²	
		solid AWG	1 x (20 to 14) / 2 x (20 to 14) AWG	
		flexible AWG	1 x (20 to 10) / 2 x (18 to 14) AWG	

**Time/Current characteristic
J7MN-3P & J7MN-3R**

J7MN-6R & J7MN-9R

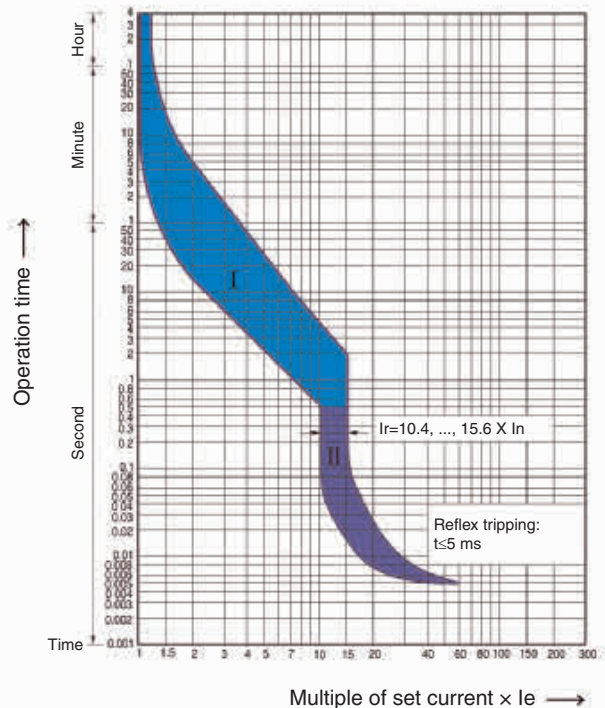
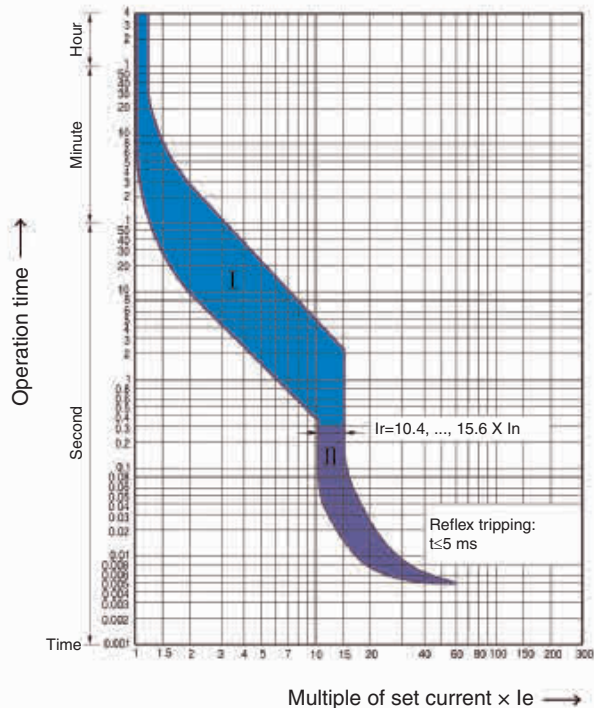

I The curve shows the mean operating current at an ambient temperature of 20°C starting from cold.
 II The tripping characteristic of electromagnetic overcurrent releases (short-circuit releases)
 The tripping characteristic of the inverse-time delayed overload releases apply for DC and AC with a frequency of 0 to 400 Hz.
 At operating temperature, the tripping times of the thermal releases are reduced to approximately 25 %.
 The characteristic shown here is a schematic representation of circuit-breakers for all ranges.
 Current limiting characteristics and I²t characteristics are available on request.

Permissible ratings of devices approved for North America

Circuit breakers J7MN as „Manual Motor Starter“

If used as „Manual Motor Starter“ the circuit breaker is always operated in combination with a short circuit device. For use with approved fuses or circuit breakers according to UL489 or CSA22.2 No. 5

only. The sizes are selected according to National Electrical Code (UL), or Canadian Electrical Code (CSA)

		J7MN-3																A	
Rated operational current	le	0.16	0.25	0.4	0.63	1	1.6	2.5	4	6	8	10	13	17	22	26	32		
Max. short-circuit current	J7MN-3P	240 V	100	100	100	100	100	100	100	100	100	50	50	40	30	30	20	kA	
		480 V	50	50	50	50	50	50	50	25	25	10	10	10	10	7.5	7.5	kA	
		600 V	10	10	10	10	10	10	10	5	5	5	5	5	5	5	5	kA	
	J7MN-3R	240 V	100	100	100	100	100	100	100	100	100	100	100	100	100	100	100	100	kA
		480 V	50	50	50	50	50	50	50	50	50	50	50	50	30	30	30	30	kA
		600 V	10	10	10	10	10	10	10	10	10	10	10	10	10	10	10	10	kA
Motor load 1-phase	115 V	-	-	-	-	-	-	-	1/8	1/4	1/3	1/2	1/2	1	1 1/2	2	2	HP	
	230 V	-	-	-	-	-	1/10	1/6	1/3	1/2	1	1 1/2	2	3	3	5	5	HP	
Motor load 3-phase	200 V	-	-	-	-	-	-	1/2	3/4	1	2	2	3	3	5	7 1/2	7 1/2	HP	
	230 V	-	-	-	-	-	1/3	1/2	1	1 1/2	2	3	3	5	7 1/2	7 1/2	10	HP	
	460V	-	-	-	-	1/2	3/4	1	2	3	5	5	7 1/2	10	15	15	20	HP	
	600V	-	-	-	-	1/2	1	1 1/2	3	5	5	10	10	15	20	20	30	HP	
Max. rated fuse		1	1	1	1	3	6	10	15	20	30	40	50	60	80	100	125	A	
Max. breaker size		15	15	15	15	15	15	15	15	20	30	40	50	60	80	100	125	A	

		J7MN-6R					J7MN-9R					A
Rated operational current	le	26	32	40	50	63	63	75	90	100		
Max. short-circuit current	240 V	100	100	100	100	100	100	100	100	100	kA	
	480 V	50	50	50	50	50	25	25	25	25	kA	
	600 V	10	10	10	10	10	10	10	10	10	kA	
Motor load 1-phase	115 V	2	3	3	5	5	5	7 1/2	10	10	HP	
	230 V	5	5	7 1/2	10	15	15	15	20	20	HP	
Motor load 3-phase	230 V	10	10	15	15	20	25	25	30	40	HP	
	460V	20	25	30	40 1/2	50	50	60	75	75	HP	
	600V	25	30	40	50	60	60	75	100	100	HP	
Max. rated fuse		100	125	150	200	250	250	300	350	400	A	
Max. breaker size		100	125	150	200	250	250	300	350	400	A	

Circuit breakers J7MN as "Combination Motor Controller Type E" and " Suitable for Group Installation"

Acc to UL508 demands a line-side 1 inch air and 2 inch creepage distance for „Combination Motor Controller Type E“ is necessary. Therefore circuit breaker J7MN-3R is approved to UL 508 in combination with the Terminal block J75-BTC-25-EC. Circuit-breakers

J7MN-9R are approved to UL 508 in combination with the insulation barriers J7MN-TB100. According to CSA these terminal blocks can be omitted when the device is used as "Combination Motor Controller Type E".

		J7MN-3R + J75-BTC-25-EC																A
Rated operational current	le	0.16	0.25	0.4	0.63	1	1.6	2.5	4	6	8	10	13	17	22	26	32	
Max. short-circuit current	240 V	100	100	100	100	100	100	100	100	100	100	100	100	100	100	100	100	kA
	480 V	50	50	50	50	50	50	50	50	50	50	50	50	30	30	30	30	kA
	600 V	10	10	10	10	10	10	10	10	10	10	10	10	10	10	10	10	kA
Motor load 1-phase	115 V	-	-	-	-	-	-	-	1/8	1/4	1/3	1/2	1/2	1	1 1/2	2	2	HP
	230 V	-	-	-	-	-	1/10	1/6	1/3	1/2	1	1 1/2	2	3	3	5	5	HP
Motor load 3-phase	200 V	-	-	-	-	-	-	1/2	3/4	1	2	2	3	3	5	7 1/2	7 1/2	HP
	230 V	-	-	-	-	-	1/3	1/2	1	1 1/2	2	3	3	5	7 1/2	7 1/2	10	HP
	460V	-	-	-	-	1/2	3/4	1	2	3	5	5	7 1/2	10	15	15	20	HP
	600V	-	-	-	-	1/2	1	1 1/2	3	5	5	10	10	15	20	20	30	HP
Max. rated fuse or breaker		500	500	500	500	500	500	500	500	500	500	500	500	500	500	500	500	A

Rated operational current	Ie	J7MN-6R					J7MN-9R + J77MN-TB100				A
		26	32	40	50	63	63	75	90	100	
Max. short-circuit current	240 V	100	100	100	100	100	100	100	100	100	kA
	480 V	50	50	50	50	50	40	40	40	40	kA
	600 V	10	10	10	10	10	10	10	10	10	kA
Motor load 1-phase	115 V	2	3	3	5	5	5	7½	10	10	HP
	230 V	5	5	7½	10	15	15	15	20	20	HP
Motor load 3-phase	230 V	10	10	15	15	20	25	25	30	40	HP
	460V	20	25	30	40	50	50	60	75	75	HP
	600V	25	30	40	50	60	60	75	100	100	HP
Max. rated fuse or breaker		600	600	600	600	600	1,000	1,000	1,000	1,000	A

Combination Motor Controller Type E			
Ratings of auxiliary switches and alarm switches	Lateral auxiliary switch with J77MN-xxS and signalling switch J77MN-T	Transversal auxiliary switch with J77MN-xxF	
Breaking capacity	A600 Q300	A300 R300	AC DC

Descriptions

Releases

Circuit-breakers J7MN are equipped with bimetallic-based, inverse-time delayed overload releases and with instantaneous overcurrent releases (electromagnetic short-circuit releases). The overload releases can be set in accordance with the load current. The overcurrent releases are permanently set to a value 13 times the rated current and thus enable trouble-free start-up of motors. The scale cover can be sealed to prevent unauthorized adjustments to the set current.

Operating mechanisms

Circuit-breakers J7MN-3P are actuated via a rocker operating mechanism and circuit-breakers J7MN-3R, J7MN-6R and J7MN-9R via a rotary operating mechanism. An electrical signal can be output, at all Circuit-breakers, via a signalling switch to indicate that the Circuit-breaker has tripped. All operating mechanisms can be locked in the 0 position with a padlock (shackle diameter 3.5 to 4.5 mm). The J7MN Circuit-breakers fulfil the isolation characteristics specified in IEC 60947-2.

Operating conditions

Circuit-breakers J7MN are suitable for use in any climate. They are designed for operation in enclosed rooms under normal conditions (e. g. no dust, corrosive vapours or harmful gases). Suitable enclosures must be provided for installation in dusty or damp rooms. Circuit-breakers J7MN can also be fed from below. In order to prevent

premature tripping due to phase failure sensitivity, the three conducting paths must always be uniformly loaded. The conducting paths must be connected in series in the case of single-phase loads.

Short-circuit protection

The short-circuit releases of J7MN circuit-breakers disconnect the faulty load feeder from the system in the event of a short circuit and thus prevent any further damage from being caused. Circuit-breakers with a short-circuit breaking capacity of 50 kA or 100 kA at a voltage of 400 V AC are practically short-circuit-proof at this voltage, as higher short-circuit currents are not usually encountered at the installation point. Back-up fuses are only necessary if the short-circuit current at the installation point exceeds the rated ultimate short-circuit breaking capacity of the circuit-breakers.

Motor protection

The tripping characteristics of J7MN circuit-breakers are designed mainly to protect three-phase induction motors. The circuit-breakers are therefore also referred to as Manual Motor Starters. The current of the motor to be protected is set with the aid of the scale.

Line protection

J7MN Circuit-breakers for motor protection are also suitable for line protection. The J7MN Circuit-breakers fulfil the isolation conditions of IEC 60 947-3 as well as the additional test conditions for circuit-breakers with isolation characteristics specified in IEC 60947-2. Taking IEC 60 204-1 into consideration, they can thus be implemented as main and EMERGENCY STOP switches. Door-coupling rotary operating mechanism do not fulfil the isolation characteristics.

Wiring diagrams

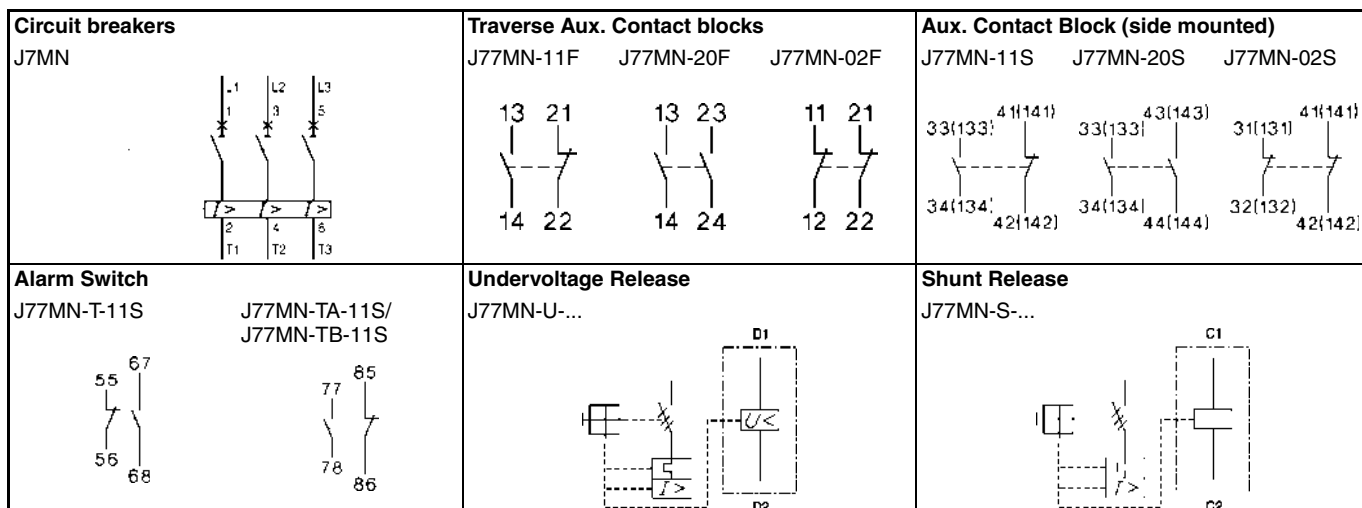

Dimensions

Circuit-breaker J7MN-3P

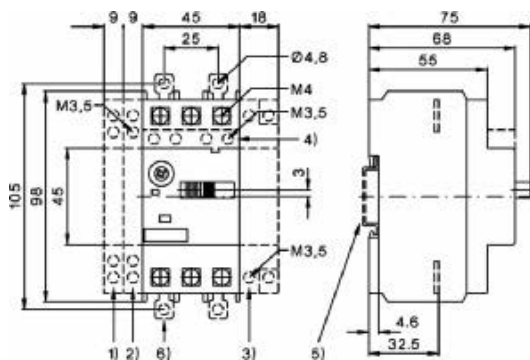
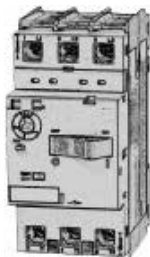

Height of arcing spaces
(clearance from earthed parts)

at Ue (V)	240	415	460	525	690
mm	20	20	20	20	20
inch	0.8	0.8	0.8	0.8	0.8

Circuit-breaker J7MN-3R

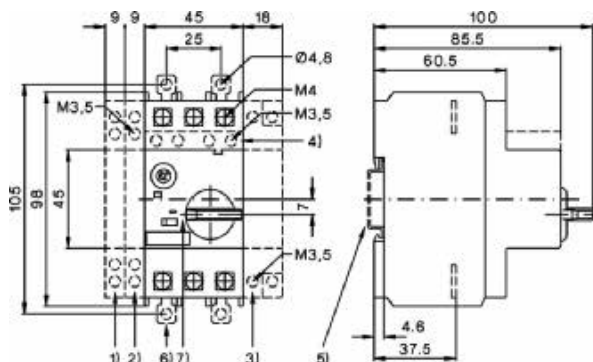
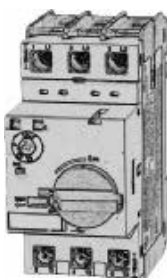

Height of arcing spaces
(clearance from earthed parts)

at Ue (V)	240	415	460	525	690
mm	30	30	30	30	50
inch	1.18	1.2	1.18	1.18	2

Circuit-breaker J7MN-6R

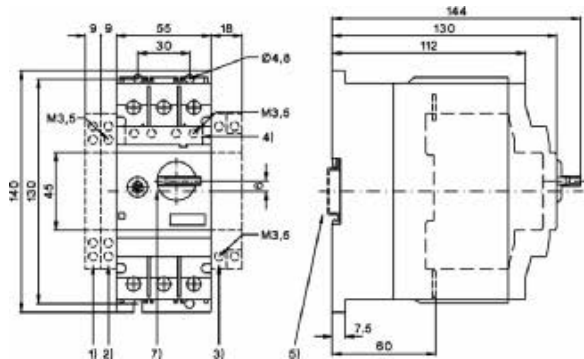

Height of arcing spaces
(clearance from earthed parts)

at Ue (V)	240	415	460	525	690
mm	50	50	50	50	50
inch	2	2	2	2	2

Circuit-breaker J7MN-9R

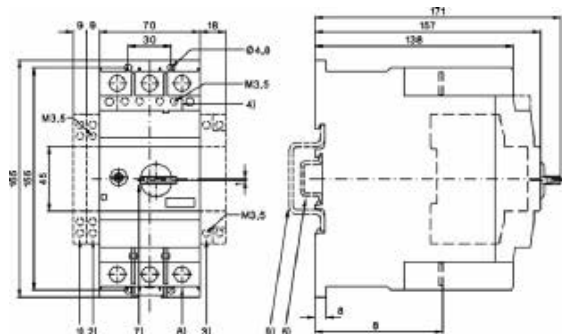
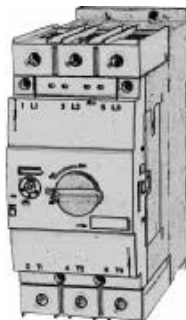

Height of arcing spaces
(clearance from earthed parts)

at Ue (V)	240	415	460	525	690
mm	50	70	70	110	150
inch	2	2 ^{3/4}	2 ^{3/4}	4.33	6

- All
- 1) Side aux. contact
 - 2) Magnetic trip alarm
 - 3) Shunt or undervoltage release of arcing
 - 4) Transverse aux. contact
 - 5) 35 mm DIN-rail acc. to EN 50022

- 3P/3R
- 3R/6R/9R
- 9R
- 6) Push-in Lugs for screw mounting
- 7) Handle lock in OFF-position (5 mm)
- 8) 4 mm hexagon socket screw
- 9) 70 mm DIN-rail acc. to EN 50023

Enclosure J77MN-PF

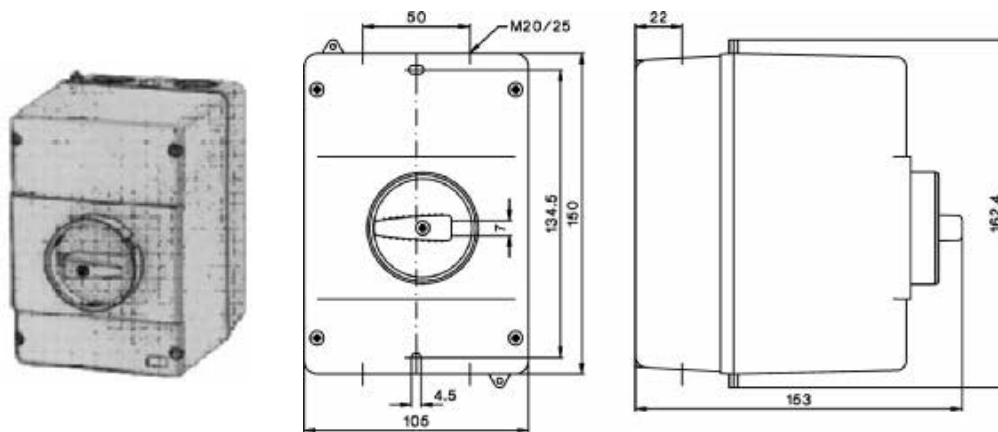

Door-coupling rotary operating mechanism J77MN-DC

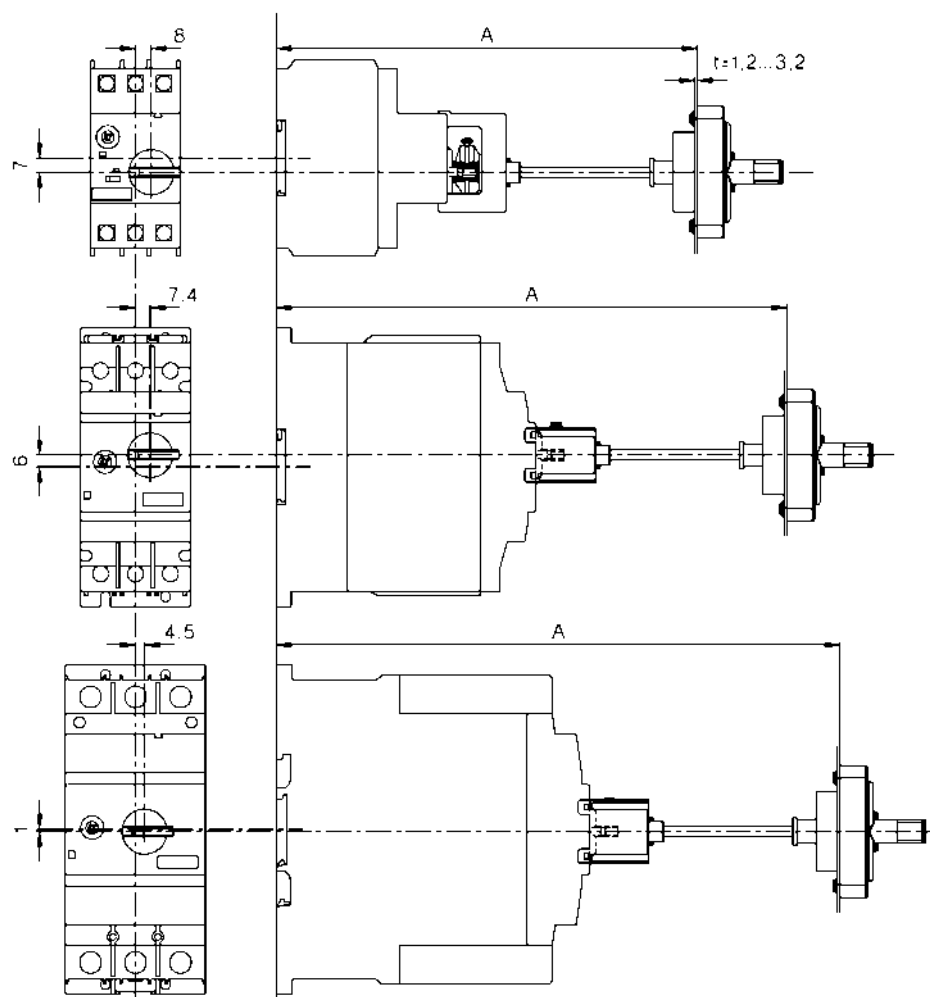

Type	A
J77MN-DC-3R-115-B	149-210
J77MN-DC-3R-115-RY	149-210
J77MN-DC-3R-315-B	149-410
J77MN-DC-3R-315-RY	149-410

Type	A
J77MN-DC-6R-115-B	194-255
J77MN-DC-6R-115-RY	194-255
J77MN-DC-6R-315-B	194-455
J77MN-DC-6R-315-RY	194-455

Type	A
J77MN-DC-9R-115-B	220-282
J77MN-DC-9R-115-RY	220-282
J77MN-DC-9R-315-B	220-482
J77MN-DC-9R-315-RY	220-482

ALL DIMENSIONS SHOWN ARE IN MILLIMETERS.

To convert millimeters into inches, multiply by 0.03937. To convert grams into ounces, multiply by 0.03527.